



FLP VX

Ex db I/IIC, Ex eb I/IIC, Ex ta IIIC, Ex nR IIC

VORTEX BARRIER GLAND for Unfilled Steel Wire Armoured Cable

Features and Benefits

- For Group I underground mines, Group II, III, Zone 1, 2, 21 and 22 hazardous areas.
- For unfilled hygroscopic multicore cables refer to IEC 60079-14; 9.3.2 and 10.6.2a, IEC 61892-7, 10.6 and 10.7.
- Two-part handling, freely rotating captive cone and inspectible cone ring provides an armour clamp and earth bond on steel wire armour.
- Factory fitted with a specially formulated elastomeric seal provides Built-in Safety™.
- Instantly mixed and injected Resin forms a 100% barrier seal around the individual cores of the cable.
- Prevents explosive gases and/or liquids transmitting down the cable.
- Precision manufactured from high-quality brass (Marine Grade Electroless Nickel Plated™) available in stainless steel 316/316L on request.
- Supplied with a thread sealing gasket (parallel threads only).



Technical Data

Type:	FLP VX (VORTEX®)
Gland Material:	Brass (Marine Grade Electroless Nickel Plated™), Stainless Steel 316/316L
Seal Material:	Standard Thermoset Elastomer or Extreme Temperature Seals, Quick setting Barrier Resin
Sealing Gasket Material:	HDPE, Nylon 66 or PTFE
Cable Type:	Steel Wire Armour
Armour Clamping:	Rotating Captive Cone and Inspectible Cone Ring
Sealing Area:	Inner Sheath and QuickStop® Resin around Cable Conductors
Optional Accessories:	Adaptor, Reducer and Shroud
Note:	The installer should ensure that the materials are suitable for the installation environment.

Standards and Certifications

Equipment Protection Levels:	IECEX/INMETRO: Ex d I Mb / IIC Gb, Ex e I Mb/IIC Gb, Ex ta IIIC Da, Ex nR IIC Gc ATEX/UKEX: Ⓢ I M2, Ⓢ II 2/3G 1D, Ex db I Mb / IIC Gb, Ex eb I Mb/IIC Gb, Ex ta IIIC Da, Ex nR IIC Gc TR CU: Ⓢ I Ex d IIC Gb X / PB Ex d I Mb X / 1Ex e IIC Gb X / ПП Ex e I Mc X / 2Ex nR IIC Gc X / Ex tb IIIC Db X	
Continuous Operating Temp:	-50°C to +95°C	
Conformance:	Standards:	Certificate:
IEC/BS EN	IEC/BS EN 62444	CML 14CA364
IECEX	IEC 60079 Part 0, 1, 7, 15, 31	IECEX TSA 22.0011X
ATEX	EN 60079 Part 0, 1, 7, 31 EN 60079 Part 0, 15	CML 16ATEX1001X CML 16ATEX4002X
UKEX	BS EN 60079 Part 0, 1, 7, 31 BS EN 60079 Part 0, 15	CML 21UKEX1011X CML 21UKEX4006X
INMETRO (Brazil)	ABNT NBR IEC 60079 Part 0, 1, 7, 15, 31	TÜV 15.0483X
TR CU (Russia)	ГОСТ 31610-0, 15, ГОСТ IEC 60079-1 ГОСТ P MЭК 60079-7, 31	EA9C RU C-ZA.HA91.B.00245/21
SANS	SANS/IEC 60079 Part 0, 1, 7, 15, 31 SANS 808	MASC MS/22-9001X
IP66/68 - Parallel	SANS/IEC 60529	MASC MS/13-028X
IP65 - Tapered	SANS/IEC 60529	
IP68 - Tapered and approved grease	IEC 60529	IECEX CML 18.0018X
Deluge Protection	DTS-01	CML 14CA370-2
Corrosion Protection	ASTM B117-11, BS EN ISO 3231	EXOVA N968667
Marine ABS	IEC 60079 Part 0, 1, 7, 15, 31, IEC 60529	ABS 20-1952706-1-PDA
DNV-GL	IEC 60079 Part 0, 1, 7, IEC 60529	DNV-GL TAE0000010
EMC Compatible	EN 55011, + A1, EN 55022	SGS EMC305079/1

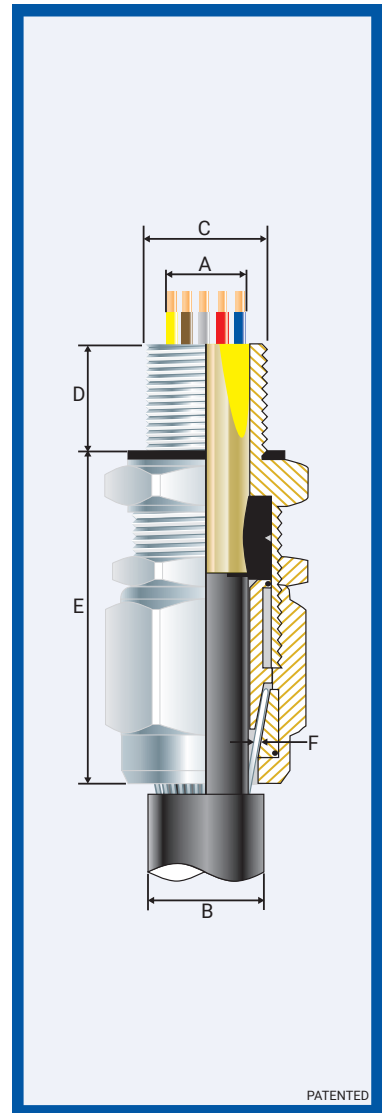

Conditions for Safe Use - X

- The cable glands shall only be used where the temperature, at the point of entry, is between -50°C and +95°C.
- Only resin supplied by CCG may be used in the glands.

Product Code	Gland Size Ref	Metric Entry Thread		NPT Entry Thread		Cable Detail			Max Length 'E'	Max Dia. Over Cores	Max No. of Cores	Armour Dia		Hexagonal Detail		Instal. Torque Value Nm
		'C'	Min 'D'	'C'	Min 'D'	Min 'A'	Max 'A'	Max 'B'				Min 'F'	Max 'F'	Max 'Flats'	Max 'Crns'	
058100-16-VX	00-16ss	M16x1.5	15	-	-	3.0	8.0	13.5	46.0	8.0	6	0.20	1.25	25.0	28.0	35.0
058100-VX	00-20ss	M20x1.5	15	½/¾	15	3.0	8.0	13.5	46.0	10.9	10	0.20	1.25	25.0	28.0	35.0
05810-VX	0-20s	M20x1.5	15	½/¾	15	8.0	11.5	16.0	46.0	10.9	10	0.20	1.25	25.0	28.0	35.0
058101-VX	1-20	M20x1.5	15	½/¾	15	11.5	14.0	19.0	48.0	12.5	13	0.20	1.25	27.0	30.0	35.0
058102-VX	2-25	M25x1.5	15	¾/1	15/19	14.0	20.2	26.5	60.0	15.5	20	0.20	1.60	40.0	45.0	50.0
058103-VX	3-32	M32x1.5	15	1/1¼	19	20.0	26.5	33.0	76.0	21.7	40	0.20	2.00	45.0	51.0	70.0
058104-VX	4-40	M40x1.5	15	1¼/1½	19/21	26.5	34.0	40.5	84.0	30.0	60	0.30	2.00	55.0	62.0	90.0
058155-VX	5s-50s	M50x1.5	15	1½/2	21	32.5	38.0	46.0	90.0	36.3	80	0.40	2.50	70.0	79.0	100.0
058105-VX	5-50	M50x1.5	15	1½/2	21	38.0	44.5	52.0	90.0	36.3	80	0.40	2.50	70.0	79.0	100.0
058165-VX	6s-63s	M63x1.5	15	2/2½	21/30	44.5	50.0	60.0	96.0	47.9	100	0.40	2.50	85.0	96.0	120.0
058106-VX	6-63	M63x1.5	15	2/2½	21/30	50.0	56.0	67.0	96.0	47.9	100	0.40	2.50	85.0	96.0	120.0
058107-VX	7-75	M75x1.5	15	2½/3	30/32	56.0	65.0	78.0	105.0	58.2	120	0.40	3.15	96.0	108.0	120.0

All dimensions except NPT are in mm. Intermediate thread sizes are available on request. NPT threads should be tightened 'wrench tight'.

CCG reserves the right to make alterations to the technical data, dimensions, designs and products available without notice. The illustrations cannot be considered binding. Please contact CCG for assistance.

FLPVX-BG010622

FLP VX (VORTEX[®]) BARRIER GLAND

ENCLOSURES AND EQUIPMENT TO WHICH CABLE GLANDS ARE FITTED:-

- Must be made from materials which are compatible with the cable gland materials.
- Have a sealing area around the cable gland entry point with a surface roughness <math>< Ra 6.3 \mu m</math>.
- Have entries that are perpendicular to the enclosure face in the area where the cable gland will seal to within 2.5°.
- Are sealed using the supplied sealing gasket (parallel threads) or by fully tightening into a threaded entry (tapered threads). Note that for tapered threads the IP rating can be improved to IP68 with the use of a suitable thread sealant.

MUST HAVE THREADED ENTRIES

- The same thread size as the cable gland. (Thread adapters should be used to correct

any mismatch).

- With a thread tolerance of metric class '6H' or equivalent.
 - Where the thread length is a minimum of 10mm for Ex d applications or 3mm for all other applications
- OR CLEARANCE HOLES** (not Ex d)
- Where the hole size is the thread nominal size with a tolerance of +0.1 to +0.7mm. (e.g. the clearance hole for an M20 thread will have a diameter between 20.1mm and 20.7mm).
 - Through material that is between 1mm and 12mm thick. (Thicker materials can be accommodated using glands with extended entry threads.)

1. Separate the inner ② from the outer ③. Cut back the cable outer sheath to expose the armour to a length as per the table below. Strip back the inner bedding to expose the inner cable cores using the cone ⑤ as a gauge.

Gland Size	Armour Length	Gland Size	Armour Length	Gland Size	Armour Length	Gland Size	Armour Length
00-16ss	20.0	1-20	25.0	4-40	30.0	6s-63s	45.0
00-20ss	20.0	2-25	25.0	5s-50s	35.0	6-63	45.0
0-20s	20.0	3-32	30.0	5-50	35.0	7-75	50.0

If the cable cores have screens these should be cut away or twisted together into a single core. This single core should be insulated with heat shrink tubing or coated with insulating varnish. Any drain wires should also be insulated with heat shrink tubing or coated with insulating varnish.

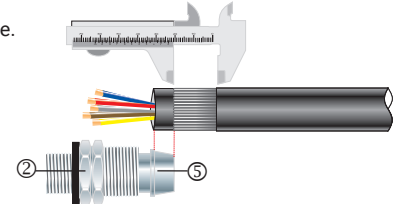

2. Using a clean cloth, clean the cable cores.
3. Using the insulation tape, bundle the cores together at the end.

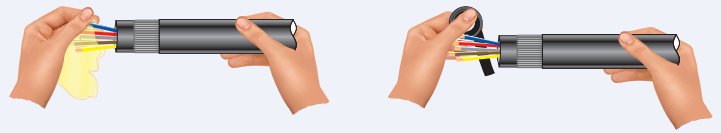

4. To maintain IP66/68, ensure the thread gasket ① is in place. Screw the inner ② into the apparatus and tighten to the installation torque using a CCG Spanner ⑩. Ensure the locknut ④ is screwed up against the inner ②. Pass the bundled cable cores through the outer ③, locknut ④, the inner ② and inner diaphragm seal and splay the armour wires over the cone ⑤.

If the gland has NPT entry threads fitted to a threaded entry then IP68 (2m) can be achieved by applying one of the following tested and approved grease types to the thread:- Renolit Lubrene CA700 or LX220 EP2, Renolit LC-WP2 or Moly LX2, or Dow Corning 4 Electrical Compound.

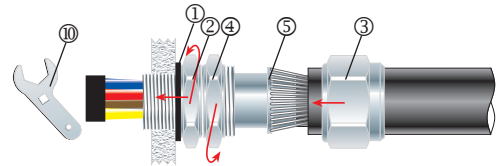

5. Tighten the outer ③ onto the inner ② until hand tight, then tighten with a CCG Spanner ⑫ with 3/4 turn to lock armour between the cone ⑤ and the cone ring ⑥.

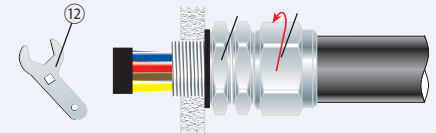

6. Unscrew the outer ③. Check that the armour has locked between the cone ⑤ and the cone ring ⑥ (O-Ring on the cone ring ⑥ is sacrificial). Withdraw the barrier pot sub-assembly ⑦ and bundled cables. Remove insulation tape.

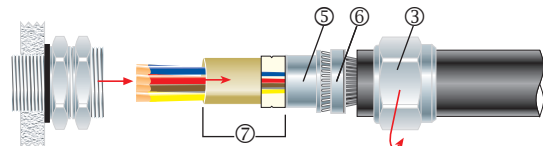

7. Remove the cap ⑩ from resin applicator and attach the mixing nozzle ⑪ (use extension nozzle for small multicore cables). Whilst holding the barrier pot sub-assembly ⑦ upright and holding the diaphragm seal firmly against the cable sheath inject the resin into the resin chamber*. Ensure the resin fills the inspectible resin seal pot ⑧ all the way to the top of the protective resin pot ⑨ and wipe any excess resin away.

Wait for the resin to set from a liquid to a gel, this should take:

- 15 minutes at 10°C
- 7 minutes at 20°C
- 6 minutes at 30°C
- 5 minutes at 40°C

For installations in less than 5°C Ambient, warm the Resin tube in warm water at ± 50°C. If there is still Resin left in the tube, discard the mixing nozzle ⑪ and replace the cap ⑩ for use with the next gland.

* The installation is acceptable if the cable sheath is pushed 2mm or 3mm into the resin seal.

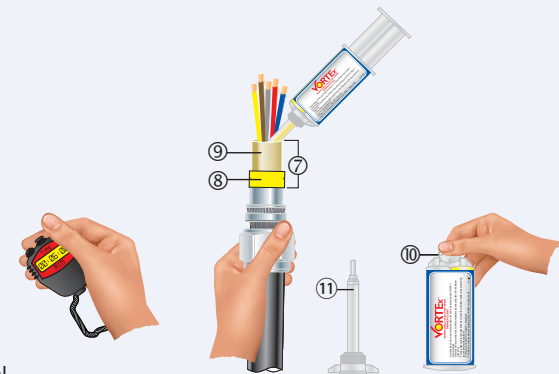

8. Re-insert the barrier pot sub-assembly ⑦ back into the inner ②.

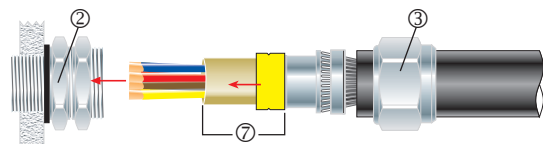

9. Tighten the outer ③ onto the inner ② to the required torque using a CCG Spanner ⑫. Tighten the locknut ④ against the outer ③.

